

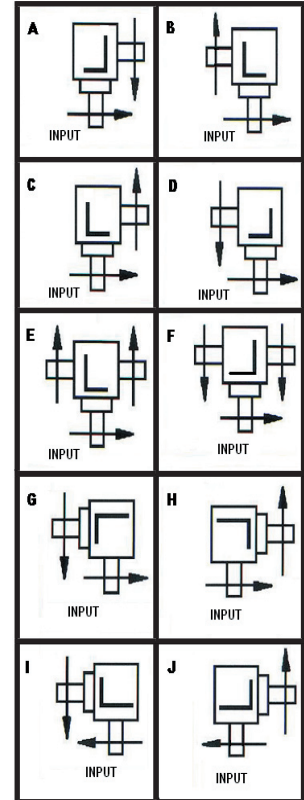

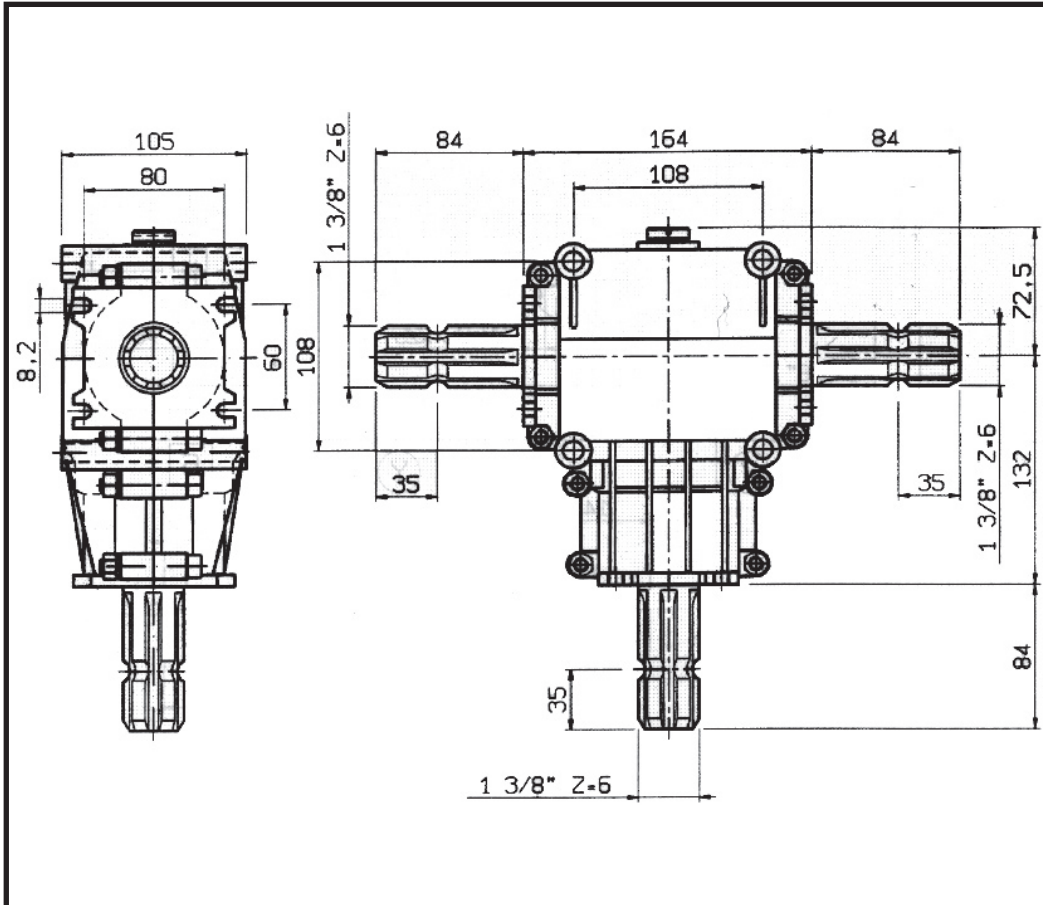

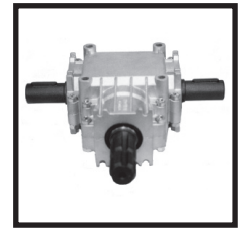

AL - 25

	7,5 Kg
	Type SAE.90EP Lt. 0,60

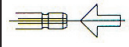

10 Z	11 Z	12 Z			
20 X-Y	21 X-Y	22 X-Y	23 X-Y	24 X-Y	

i														agmaster by WALTERSCHEID
	r.p.m.	r.p.m.	HP	KW	Nm	X	Y	Z			Ref.			
2,90 : 1	540	186	10	7,5	365	21	21	11	Z	E - F	8305033			
2,90 : 1	540	186	10	7,5	365	21		11	Z	A - B	8305034			
2,90 : 1	540	186	10	7,5	365		21	11	Z	C - D	8305035			
2 : 1	540	270	15	11	377	21	21	11	Z	E - F	8305030			
2 : 1	540	270	15	11	377	21		11	Z	A - B	8305031			
2 : 1	540	270	15	11	377		21	11	Z	C - D	8305032			
1,46 : 1	540	370	18	13	330	21	21	11	Z	E - F	8305027			
1,46 : 1	540	370	18	13	330	21		11	Z	A - B	8305028			
1,46 : 1	540	370	18	13	330		21	11	Z	C - D	8305029			
1 : 1	540	540	25	18,5	345	21	21	11	Z	E - F	8305024			
1 : 1	540	540	25	18,5	345	21		11	Z	A - B	8305025			
1 : 1	540	540	25	18,5	345		21	11	Z	C - D	8305026			
1 : 1,46	540	788	25	18,5	149	21		11	X	I - J	8305036			
1 : 1,46	540	788	25	18,5	149		21	11	Y	G - H	8305037			
1 : 2	540	1080	25	18,5	165	21		11	X	I - J	8305038			
1 : 2	540	1080	25	18,5	165		21	11	Y	G - H	8305039			
1 : 2,90	540	1566	22	16	157	21		11	X	I - J	8305040			
1 : 2,90	540	1566	22	16	157		21	11	Y	G - H	8305041			