







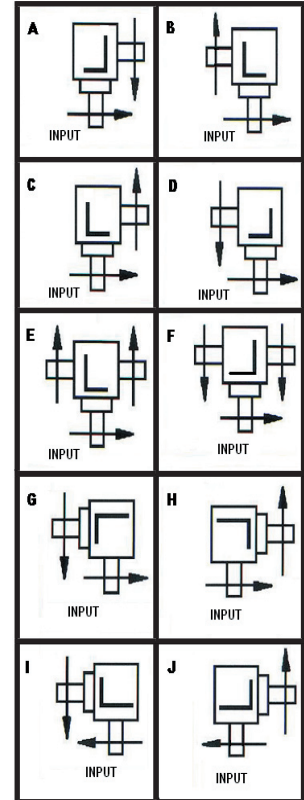
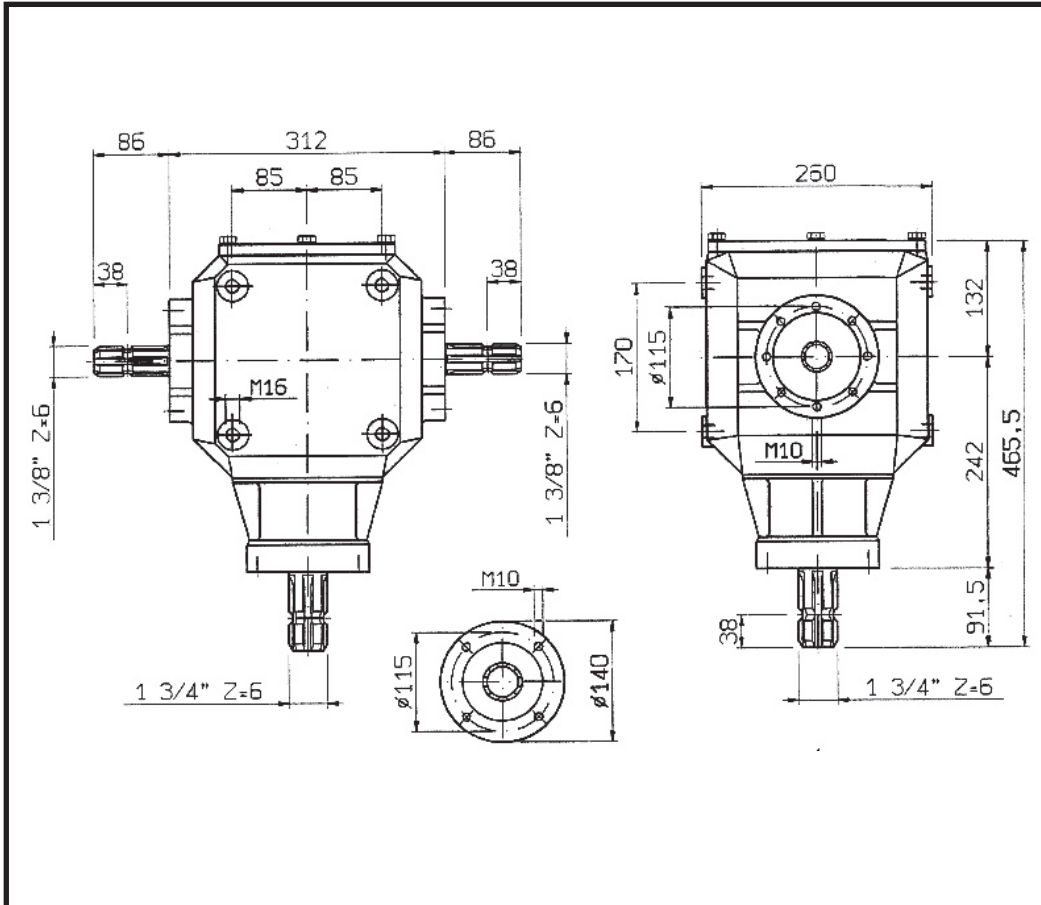
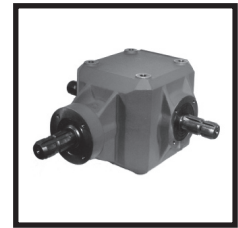
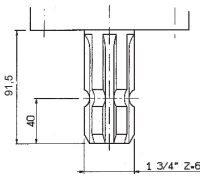
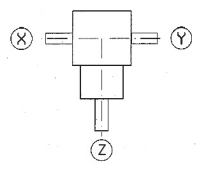
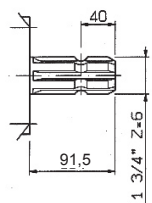
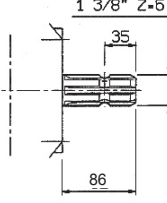
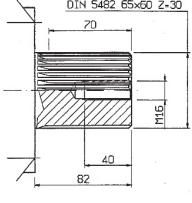
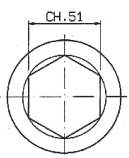

T - 150

	55 Kg
	Type SAE.90EP Lt. 4,00

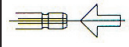

					
10	Z				
					
20	X-Y	21	X-Y	22	X-Y
				23	X-Y

T - 150

i												agmaster by WALTERSCHEID
	r.p.m.	r.p.m.	HP	KW	Nm	X	Y	Z			Ref.	
4,10 : 1	540	132	40	30	2061	20	20	10	Z	E - F	8305186	
4,10 : 1	540	132	40	30	2061	20		10	Z	A - B	8305187	
4,10 : 1	540	132	40	30	2061		20	10	Z	C - D	8305188	
3 : 1	540	180	55	41	2078	20	20	10	Z	E - F	8305183	
3 : 1	540	180	55	41	2078	20		10	Z	A - B	8305184	
3 : 1	540	180	55	41	2078		20	10	Z	C - D	8305185	
2 : 1	540	270				20	20	10	Z	E - F	8305180	
2 : 1	540	270				20		10	Z	A - B	8305181	
2 : 1	540	270					20	10	Z	C - D	8305182	
1,5 : 1	540	360				20	20	10	Z	E - F	8305177	
1,5 : 1	540	360				20		10	Z	A - B	8305178	
1,5 : 1	540	360					20	10	Z	C - D	8305179	
1 : 1	540	540	150	112	1889	20	20	10	Z	E - F	8305174	
1 : 1	540	540	150	112	1889	20		10	Z	A - B	8305175	
1 : 1	540	540	150	112	1889		20	10	Z	C - D	8305176	
1 : 1,5	540	810				20		10	X	I - J	8305178	
1 : 1,5	540	810					20	10	Y	G - H	8305179	
1 : 2	540	1080				20		10	X	I - J	8305181	
1 : 2	540	1080					20	10	Y	G - H	8305182	
1 : 3	540	1620				20		10	X	I - J	8305184	
1 : 3	540	1620					20	10	Y	G - H	8305185	
1 : 4,10	540	2214				20		10	X	I - J	8305187	
1 : 4,10	540	2214					20	10	Y	G - H	8305188	