

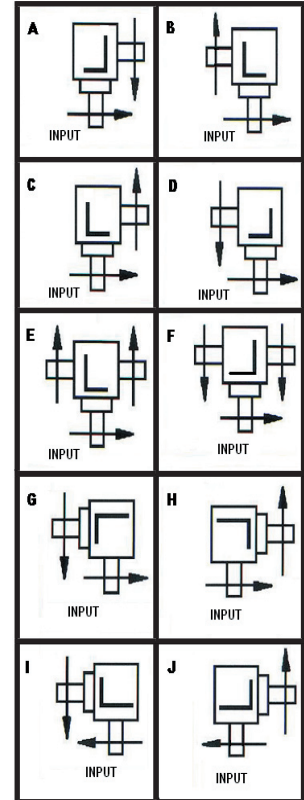

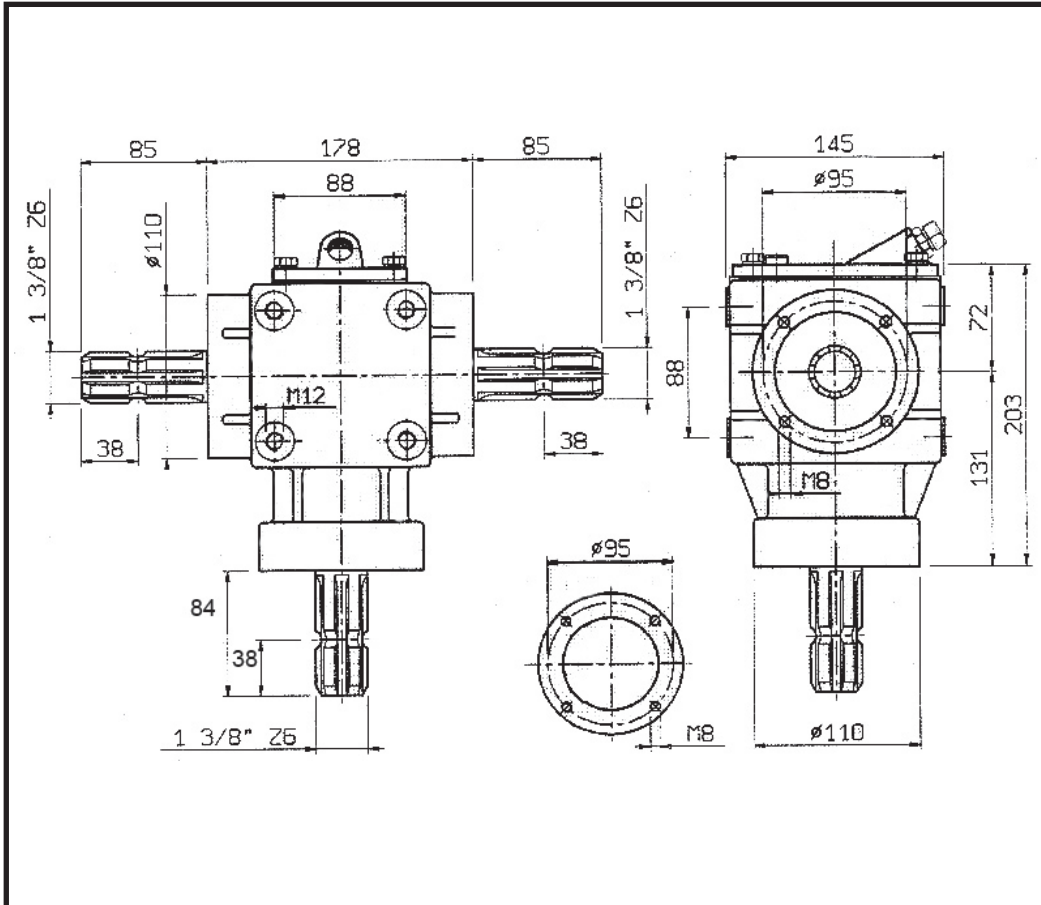



# TV - 145

	48 Kg
	Type SAE.90EP Lt. 2,30

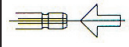

10	11	30	31
Z	Z	Z	Z
20	21	22	23
X-Y	X-Y	X-Y	X-Y

i														agmaster by WALTERSCHEID
	r.p.m.	r.p.m.	HP	KW	Nm	X	Y	Z			Ref.			
4,11 : 1	540	131	37	27	40	20	20	10	Z	E - F	8305146			
4,11 : 1	540	131	37	27	40	20	20	10	Z	E - F	8305217			
4,11 : 1	540	131	37	27	40	20		10	Z	A - B	8305147			
4,11 : 1	540	131	37	27	40		20	10	Z	C - D	8305148			
3,10 : 1	540	174	55	40	2218	20	20	10	Z	E - F	8305143			
3,10 : 1	540	174	55	40	2218	20	20	11	Z	E - F	8305216			
3,10 : 1	540	174	55	40	2218	20		10	Z	A - B	8305144			
3,10 : 1	540	174	55	40	2218		20	10	Z	C - D	8305145			
2,46 : 1	540	220	63	46	2016	20	20	10	Z	E - F	8305140			
2,46 : 1	540	220	63	46	2016	20		10	Z	A - B	8305141			
2,46 : 1	540	220	63	46	2016		20	10	Z	C - D	8305142			
1,93 : 1	540	280	90	66	2260	20	20	10	Z	E - F	8305137			
1,93 : 1	540	280	90	66	2260	20	20	11	Z	E - F	8305215			
1,93 : 1	540	280	90	66	2260	20		10	Z	A - B	8305138			
1,93 : 1	540	280	90	66	2260		20	10	Z	C - D	8305139			
1 : 1,93	540	1042	145	107	978	20		10	X	I - J	8305138			
1 : 1,93	540	1042	145	107	978		20	10	Y	G - H	8305139			
1 : 2,46	540	1328	120	88	635	20		10	X	I - J	8305141			
1 : 2,46	540	1328	120	88	635		20	10	Y	G - H	8305142			
1 : 3,10	540	1674	120	88	504	20		10	X	I - J	8305144			
1 : 3,10	540	1674	120	88	504		20	10	Y	G - H	8305145			
1 : 4,11	540	2219	90	66	285	20		10	X	I - J	8305147			
1 : 4,11	540	2219	90	66	285		20	10	Y	G - H	8305148			